

MobileMark
antenna solutions



COMTELCO

ANTENNAS

A Family Brand of Mobile Mark

LMR, VHF, UHF, P25 & ISM
Product Catalog

Innovative antenna designs • Responsive manufacturing • Trusted partner

Since 1982 Comtelco antennas have established a long history of success, a solid reputation, and dedication to their customers by providing high-quality antenna solutions for commercial wireless applications. For over 40 years the Comtelco Brand has continued to evolve offering reliability, high-performance antennas, and value to our customers, driven by the desire to become the **Easiest to do Business** with. These values are embodied in its parent company, Mobile Mark Inc.

As an Industry leader and Innovator of high-performance antennas, Mobile Mark, Inc. provides **Complete Antenna Solutions** by offering tailored technical solutions to the wireless industry and wireless companies across the globe. From humble beginnings that started over 35 years ago with the early Cellular trials, we have grown to become wireless **Knowledge Experts**. Our success and growth over the decades are due in part to the fact we continuously change and improve, just as the industry continues to evolve.

To this end, we persist in investing in product development, expanding our engineering capabilities to take a project from the initial concept stage through final production, and creating a standard of **Engineering Excellence** second to none. However, we know that being wireless experts and offering tailored engineering solutions is not enough if you can't transform ideas into tangible products at a rapid pace. That is why we've developed an in-house rapid prototyping process that allows us to take our designs from concept to installation in extremely short periods, while always verifying the performance of the antenna.

This **Production Flexibility** includes a variety of critical network analyzers and an anechoic chamber enabling us to conduct measurements up to 13GHz and ensuring that the antenna design meets our stringent requirement standards while exceeding your expectations.

Our success over the decades has enabled us to move into larger facilities in both the US and the UK, expanding plant capacity to meet OEM and market volume requirements, while keeping true to a core value of Design, Quality, and Manufacturing locally, **"Made-in-the-USA"** and in the UK for our European and African partners. With onsite injection molding, a modeling shop that includes a CNC machine, operated by a skilled team working together to produce a superior product antenna designed to seamlessly blend in with today's environmental ecstastic, yet products that meet the required technical specifications and exceed our customer's expectations.

We are proud of our successful history of offering exceptional antenna product solutions, legendary customer service, and core business values. We'd like to thank our long-time customers for their loyalty, and the strong partnership that exists. Mobile Mark is committed to Moving Wireless Forward®.



TABLE OF CONTENTS

XL Series (BS) Base Station Antennas	3
Dual Band BS Base Station Antennas	3
BSL Heavy Duty Base Station Antennas & Mounting Kits	4
BSLL Super Duty Base Station Antennas & Mounting Kits.	5
Folded Dipole Antennas & Couplers	5
Marine Antennas & Mounts	6
Panel Antennas & Mounts	7
Standard & Heavy Duty Yagi Antennas	9
Fully Welded & Enclosed Feed Yagis.	10
Accessories for Yagi Antennas	10
Low Band Spring Loaded Antennas	11
VHF, UHF, 800 MHz Base Loaded Antennas	12
Quarterwave Antennas, 54-970 MHz.	12
Mobile Gain Antennas, 430-970 MHz.	13
Mobile Gain Antennas, 735-1000 MHz & 2.4 GHz	14
Multi Band Mobile Antennas.	15
VHF/UHF Diplexer & VHF,UHF/800 Triplexer.	15
Low Profile Antennas	16
Ceiling Mount Antennas	17
Couplers, Stackers & Specialty Antennas.	17
Permanent Body Mounts for Mobile Antennas.	19
Magnetic & Trunk Mounts	20
Specialty Mounts & Brackets	21
Accessories	22

**Easy To Do Business With
Manufacturing & Global Distribution Locations.**



Moving Wireless Forward®

As a result of our commitment to moving wireless forward and we are proud to offer an expanded antenna product selection giving wider solutions for nearly every application. We have developed some new methods, using modular power dividers and special mounting options to provide simple, easy to install ways to send signals in multiple directions.

ED & EDX FOLDED DIPOLES | The ED450, ED220 and ED150 are self-contained units with integrated masts and internal wiring. The EDX450, EDX220 and EDX150 are bolt-on elements that are designed for simple installation on a user supplied mast.

Y66 SERIES FULLY WELDED YAGIS | The Y66 Series yagis feature 3/8" solid elements and an entirely enclosed feed system.

NO TUNE, WIDE BAND MOBILE ANTENNAS | A15WB698A 698-2700MHz

NO TUNE, TRI - BAND ANTENNAS | A55136TB, TBS 136-174MHz, 380-490MHz, 698-870MHz

NO TUNE, LOW BAND, WIDE BAND | The A18HDWB series antennas provide wider bandwidth operation with no tuning or cutting across the specified frequency range.

BSJ727 | The BSJ727 is a 3dBd outdoor omni-directional base station antenna covering 698MHz- 2700MHz. The radome is polyester coated fiberglass and various mount arrangements are available.

BCM727 | This antenna is a ceiling mount omni-directional antenna covering 698MHz-2700MHz. Specifications for these antennas can be found on our web site.

Y442458HDSM | This antenna is a log periodic Yagi antenna that covers all bands between 1.6GHz and 6.0GHz. It provides 8dBi gain in an enclosed radome with a swivel mount. It is an outstanding choice as a directional outdoor antenna.

Y42400WB & Y42700WB | These wide band Yagi antennas are fully welded and epoxy powder coated. They have an enclosed feed for outstanding environmental stability. They feature a log periodic design. The Y42400WB covers from 400MHz to 800MHz. The Y42700WB covers from 600MHz to 6000MHz. The Y42700WB-2X antenna consists of two of the Y42700WB on a single mounting platform for convenient 2xMIMO coverage.

2Y6623CC | Bi-directional antenna system featuring 2-Y6623 Yagi antennas with a CC220 power divider with optional mounting hardware.

BCM24MIMO | These antennas provide 3dBd/5dBi gain in a multiple in multiple out configuration. Designed for indoor or outdoor service. They have a power handling capacity of 150 watts. The BCM24MIMO provides excellent performance over a wide frequency spectrum.



A STEP ABOVE - COMPARE OUR FULL ELEMENT CONSTRUCTION

BASE STATION ANTENNAS

Made Locally - Comtelco and Mobile Mark branded base station antennas are manufactured in either our Illinois or Hedgesford facility.

State-of-Art and Excellent Value - Our antennas are manufactured using proven design techniques and specialized materials that provide economical and reliable long-term operation. Our flexible production is constantly being reviewed and improved, ensuring the very best possible product is always being shipped to our customers.

Redefining Long-term - All these products have been designed and manufactured for long-term reliability.

Options for Specific Applications - Omnidirectional base station antennas are primarily center fed dipoles, available in various configurations. We also offer both standard bandwidth and wide bandwidth antennas at certain frequencies.

What's On the Inside - Base Station construction features high quality copper alloy elements soldered and/or welded for electrical mechanical integrity.

Not Just a Pretty Face - The element structure is encased in a UV inhibited fiberglass Radom assuring long life and excellent resistance to harsh environments.

Designs With the Right Stuff - We offer designs that allow for tough, high power handling capability while minimizing intermodulation. Construction of this type is not usually used in lower cost base station antennas.

The Details Make the Difference - A complete drain system provides the necessary means of dissipating any moisture buildup from condensation caused by temperature fluctuations.

Setting the Bar - Our 1.5" diameter heavy-duty BSL series base station antennas are robust antennas, built to stand up to the most demanding applications. They set a new standard for reasonably priced, heavy-duty base station antennas.

What You Need and More - A complete lineup of mounting accessories is available to support the Comtelco brand base station antenna product line.

Galvanized Steel - Tower support arms provide rugged mounting for antennas that must stand off tower legs.

We're Easy To Do Business With, but Our Assemblies are Easier - Stainless steel mount kits, V-bolt brackets and powder-coated aluminum block assemblies allow ease of mounting and resistance to corrosion.

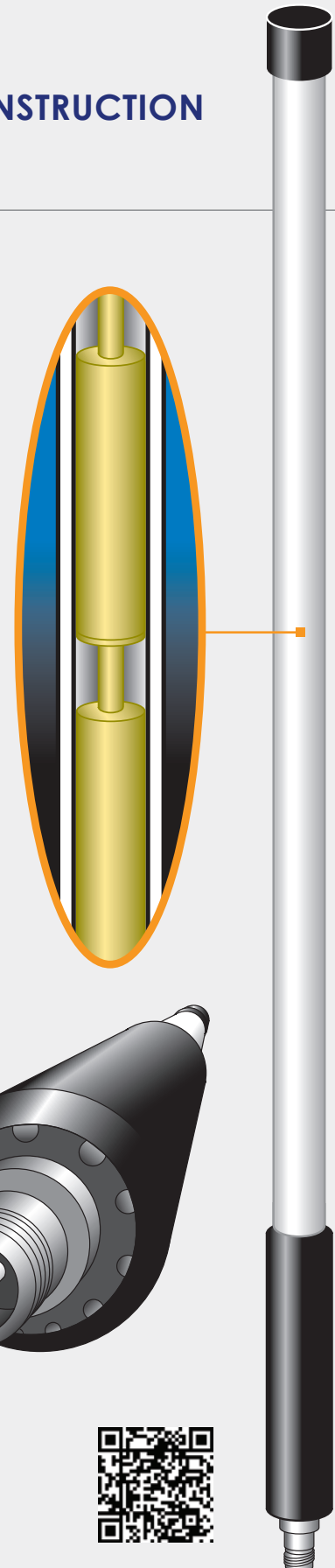

XL SERIES BASE STATION ANTENNAS

VHF Unity Gain, 96"

Custom order center frequencies

BS100U-XX	75-140MHz
-----------	-----------

VHF Unity Gain, 64"

BS150U-A	144-150MHz
BS150U-B	150-156MHz
BS150U-BC	153-159MHz
BS150U-C	156-162MHz
BS150U-D	162-168MHz
BS150U-E	168-174MHz
BS220U-A	200-210MHz
BS220U-B	210-220MHz
BS220U-C	215-225MHz

VHF 3dBd Gain, 98"

BS150XL3-A	144-150MHz
BS150XL3-B	150-156MHz
BS150XL3-BC	153-159MHz
BS150XL3-C	156-162MHz
BS150XL3-D	162-168MHz
BS150XL3-E	168-174MHz
BS220XL3-A	200-210MHz
BS220XL3-B	210-220MHz
BS220XL3-C	215-225MHz

375MHz 3dBd Gain, 36"

BS380XL3-A	375-400MHz
------------	------------

UHF Unity Gain, 32"

BS450U-A	406-430MHz
BS450U-B	430-450MHz
BS450U-BC	445-465MHz
BS450U-C	450-470MHz
BS450U-CD	460-480MHz
BS450U-D	470-490MHz
BS450U-DE	480-500MHz
BS450U-E	490-512MHz

UHF Wide Band

BS450U-WB	Unity Gain 450-512MHz 32"
BS450XL3-WB	3dB Gain 450-512MHz 67"

UHF 3dBd Gain, 36"

BS450XL3-A	406-430MHz
BS450XL3-B	430-450MHz
BS450XL3-BC	445-465MHz
BS450XL3-C	450-470MHz
BS450XL3-CD	460-480MHz
BS460XL3	460-533MHz
BS450XL3-D	470-490MHz
BS450XL3-DE	480-500MHz
BS450XL3-E	490-512MHz

UHF 4.5dBd Gain, 67"

BS450XL4.5-A	406-430MHz
BS450XL4.5-B	430-450MHz
BS450XL4.5-BC	445-465MHz
BS450XL4.5-C	450-480MHz
BS450XL4.5-D	470-490MHz
BS450XL4.5-DE	480-500MHz
BS450XL4.5-E	490-512MHz

UHF 6dBd Gain, 98"

BS450XL6-A	406-440MHz
BS450XL6-B	440-460MHz
BS450XL6-C	450-470MHz
BS450XL6-D	460-480MHz
BS450XL6-E	480-512MHz

500/600MHz 3dBd Gain, 21"

BS530XL3	530-578MHz
BS578XL3	578-650MHz
BS650XL3	650-698MHz
BS698XL3	698-870MHz

700MHz 5dBd Gain, 62"

BS725XL5	690-746MHz
BS750XL5	746-796MHz

700/800MHz Unity Gain Wide Band, 20"

BS750UWB	746-896MHz
BS800UWB	806-960MHz
BSM800UWB	806-960MHz

All lengths of base station antennas are maximum. See Data Sheets on Web for exact lengths.

698-2700MHz 3dBd Full Spectrum

BS896UWBT	806-960 MHz
BSM698FS3BKT	698-2700MHz

800MHz 3dBd Wide Band Gain, 38"

BS800XL3WB	806-960MHz
BSM800XL3WB	806-960MHz

900MHz 3dBd Gain, 36"

BS915XL3	900-930MHz
----------	------------

800/900MHz 5dBd Gain, 50"

BS800XL5-A	806-866MHz
BS800XL5-C	825-896MHz
BS800XL5-E	890-970MHz
BS915XL5	900-930MHz

800/900MHz 6.5dBd Gain, 62"

BS800XL7-A	806-866MHz
BS800XL7-C	825-896MHz
BS800XL7-E	890-970MHz
BS915XL7	900-930MHz



- Copper alloy elements in UV white fiberglass tube
- Type N female termination, options available
- Heavy wall epoxy coated aluminum sleeve
- 150 MPH wind survival, 250 watt power rating

1GHZ through 6GHz

BS1350XL5-WB	1200-1550MHz, 6.5dBi, 40"
BS1710XL3	1710-1850MHz, 5dBi, 18"
BS1710XL6	1710-1850MHz, 7.5dBi, 24"
BS1850XL3	1850-1990MHz, 5dBi, 18"
BS1850XL6	1850-1990MHz, 7.5dBi, 24"
BS2400XL3	2400-2500MHz, 5dBi, 18"
BS2400XL6	2400-2500MHz, 7.5dBi, 24"
BS2400XL12	2400-2500MHz, 14dBi, 60"
BS3500XL6	3300-3600MHz, 8dBi, 24"
BS5800XL10	5.72-5.92GHz, 12dBi, 30"

Dual Band VHF / UHF Unity Gain

Custom order center frequencies

BSDB31U	140-174 / 440-512MHz, 67"
BSDB31U9	315-325 / 900-930MHz, 38"

Tri Mode 800 / 1900 Cell / PCS 3dB, 17"

BSDB18U8	825-896 / 1850-1990MHz
BSDB18U9	921-960 / 1805-1880MHz
BSMNT1	Single XL Mount Bracket
BSMNT2	Dual XL Mount Bracket



BSL SERIES HEAVY DUTY BASE STATION ANTENNAS

HF Unity Gain, 144"

Custom order center frequencies

BSL50U-XX 45-75MHz

(Not UPS Shippable)

VHF Unity Gain, 96"

Custom order center frequencies

BSL100U-XX 75-140MHz

VHF Unity Gain, 64"

BSL150U-A 144-150MHz

BSL150U-B 150-156MHz

BSL150U-C 156-162MHz

BSL150U-D 162-168MHz

BSL150U-E 168-174MHz

BSL220U-A 200-210MHz

BSL220U-B 210-220MHz

BSL220U-C 215-225MHz

VHF 3dBd Gain, 98"

BSL150XL3-A 144-150MHz

BSL150XL3-B 150-156MHz

BSL150XL3-C 156-162MHz

BSL150XL3-D 162-168MHz

BSL150XL3-E 168-174MHz

BSL220XL3-A 200-210MHz

BSL220XL3-B 210-220MHz

BSL220XL3-C 215-225MHz

UHF Unity Gain, 32"

BSL450U-A 406-430MHz

BSL450U-B 430-450MHz

BSL450U-BC 445-465MHz

BSL450U-C 450-470MHz

BSL450U-CD 460-480MHz

BSL450U-D 470-490MHz

BSL450U-DE 480-500MHz

BSL450U-E 490-512MHz

UHF 4.5dBd Gain, 67"

BSL450XL4.5-A 406-430MHz

BSL450XL4.5-B 430-450MHz

BSL450XL4.5-C 450-480MHz

BSL450XL4.5-D 470-490MHz

BSL450XL4.5-E 490-512MHz

UHF 6dBd Gain, 98"

BSL450XL6-A 406-440MHz

BSL450XL6-B 440-460MHz

BSL450XL6-C 450-470MHz

BSL450XL6-D 460-480MHz

BSL450XL6-E 480-512MHz

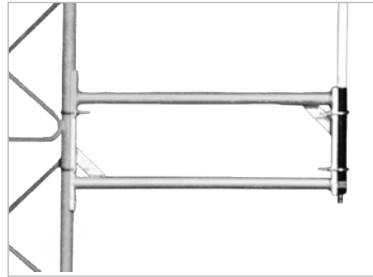

BSSMNT10 Single Side Mount with U Bolts

800/900MHz Wide Band Unity Gain, 20"

BSL800UWB 806-960MHz

800/900MHz Wide Band 3dBd Gain, 38"

BSL800XL3WB 806-960MHz

900MHz 3dBd Gain, 36"

BSL915XL3 900-930MHz

800/900MHz 5dBd Gain, 50"

BSL800XL5-A 806-866MHz

BSL800XL5-C 825-896MHz

BSL800XL5-E 890-970MHz

BSL915XL5 900-930MHz

800/900MHz 6.5dBd Gain, 62"

BSL800XL7-A 806-866MHz

BSL800XL7-C 825-896MHz

BSL800XL7-E 890-970MHz

BSL915XL7 900-930MHz

Dual Band VHF / UHF Unity Gain

Custom order center frequencies

BSLDB31U 140-174 / 440-512MHz 67"

BSLDB31U9 315-325 / 900-930MHz 38"

All lengths of base station antennas are maximum.
See Data Sheets on Web for exact lengths.

1GHZ through 6GHZ

BSL1350XL5 1200-1550MHz, 6.5dBi, 40"

BSL1710XL3 1710-1850MHz, 5dBi, 18"

BSL1710XL6 1710-1850MHz, 7.5dBi, 24"

BSL1850XL3 1850-1990MHz, 5dBi, 18"

BSL1850XL6 1850-1990MHz, 7.5dBi, 24"

BSL2400XL3 2400-2500MHz, 5dBi, 18"

BSL2400XL6 2400-2500MHz, 7.5dBi, 24"

BSL2400XL12 2400-2500MHz, 14dBi, 60"

800 / 1900 Cell / PCS 3dB, 16"

BSLDB18U8 825-896 / 1850-1990MHz

BSLDB18U9 921-960 / 1805-1880MHz

- Large diameter fiberglass base station antenna
- 1 1/2" diameter tube, 2" diameter mounting sleeve
- Fits 2 3/8" mast
- All XL series antennas available in BSL version
- Use BSLMNT2 mount for easy assembly



BST



U Bolt



BSLMNT2



BSL

Base Station Mounting Kits

BST	Low Cost Mount with V Bolts
BSMNT1	Single XL Mount Bracket
BSMNT2	Dual XL Mount Bracket
BSLMNT2	Dual BSL & BSLL Mount Bracket
BSLLUMNT1-2	BSL & BSLL Universal Mount Bracket with 2 Bolts
BSLLUMNT2-4	Dual BSL & BSLL Universal Mount Bracket with 4 Bolts
BSSMNT10-2	Single Side Mount With 2 U Bolts
BSSMNT10-4	Single Side Mount With 4 U Bolts

BSLL SERIES SUPER DUTY BASE STATION ANTENNAS

HF Unity Gain, up to 168"

BSLL150U-XX	45-75MHz
-------------	----------

(Not UPS Shippable)

VHF Unity Gain, 96"

BSLL100U-XX	75-140MHz
-------------	-----------

VHF Unity Gain, 64"

BSLL150U-A	144-150MHz
BSLL150U-B	150-156MHz
BSLL150U-C	156-162MHz
BSLL150U-D	162-168MHz
BSLL150U-E	168-174MHz
BSLL220U-A	200-210MHz
BSLL220U-B	210-220MHz
BSLL220U-C	215-225MHz

VHF 3dBd Gain, 98"

BSLL150XL3-A	144-150MHz
BSLL150XL3-B	150-156MHz
BSLL150XL3-C	156-162MHz
BSLL150XL3-D	162-168MHz
BSLL150XL3-E	168-174MHz
BSLL220XL3-A	200-210MHz
BSLL220XL3-B	210-220MHz
BSLL220XL3-C	215-225MHz

UHF Unity Gain, 32"

BSLL450U-A	406-430MHz
BSLL450U-B	430-450MHz
BSLL450U-BC	445-465MHz
BSLL450U-C	450-470MHz
BSLL450U-CD	460-480MHz
BSLL450U-D	470-490MHz
BSLL450U-DE	480-500MHz
BSLL450U-E	490-512MHz

UHF 4.5dBd Gain, 67"

BSLL450XL4.5-A	406-430MHz
BSLL450XL4.5-B	430-450MHz
BSLL450XL4.5-C	450-480MHz
BSLL450XL4.5-D	470-490MHz
BSLL450XL4.5-E	490-512MHz

UHF 6dBd Gain, 98"

BSLL450XL6-A	406-440MHz
BSLL450XL6-B	440-460MHz
BSLL450XL6-C	450-470MHz
BSLL450XL6-D	460-480MHz
BSLL450XL6-E	480-512MHz

800/900MHz Wide Band Unity Gain (806-960MHz), 20"

BSLL800UWB	806-960MHz
------------	------------

800/900MHz Wide Band 3dBd Gain (806-960MHz), 38"

BSLL800XL3WB	806-960MHz
--------------	------------

900MHz 3dBd Gain, 36"

BSLL915XL3	900-930MHz
------------	------------

800/900MHz 5dBd Gain, 50"

BSLL800XL5-A	806-866MHz
BSLL800XL5-C	825-896MHz
BSLL800XL5-E	890-970MHz
BSLL915XL5	900-930MHz

800/900MHz 6.5dBd Gain, 62"

BSLL800XL7-A	806-866MHz
BSLL800XL7-C	825-896MHz
BSLL800XL7-E	890-970MHz
BSLL915XL7	900-930MHz

All lengths of base station antennas are maximum. See Data Sheets on Web for exact lengths.

BSLL Mounting Kits

BSLLUMNT1-2	BSL & BSLL Universal Mount Bracket with 2 Bolts
BSLLUMNT2-4	Dual BSL & BSLL Universal Mount Bracket set with 4 Bolts
BSLLUMNT1-4	BSL & BSLL Rotatable Mount Bracket with 4 Bolts
BSLLUMNT2-8	Dual BSL & BSLL Mount Bracket set with 8 Bolts



BSLL

- Very large diameter fiberglass base station antenna
- 2" diameter tube, 2 1/2" diameter mounting sleeve
- Allows for very robust construction especially important in low band operation
- Most XL series antennas are also available in BSLL version
- Use BSLLUMNT2-4 or BSLMNT2 Mount for easy assembly

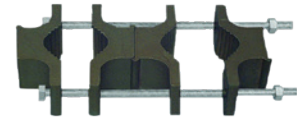

BSLLUMNT1-2

FOLDED DIPOLE ANTENNAS

Folded Dipole antennas are chosen for many applications because of their inherent flexibility. They can be used either as omni-directional or as directional antennas. They generally provide wider bandwidths than other forms of dipole antennas.

Folded Dipole Element 2.5dBd Gain, 1-Element, N-Male

(Includes 1-Element and mounting hardware)

EDX150	150-174MHz
EDX220	220-225MHz
EDX450	406-512MHz
EDX470WB	470-698MHz

For Double Element EDX you will need:

CC150-2	150-250MHz
CC220-2	200-550MHz
CC450-2	400-512MHz

BKT1 Mount for CC Series Power Divider

Folded Dipole 2.5dBd Gain, 1-Radiating Element, N-Male

(Includes 1 Elements and Mast)

ED150-1	150-174MHz
ED450-1	406-512MHz
ED450-2	406-512MHz, two elements



Double Element EDX
EDX450, EDX450, CC450-2, BKT1



EDX150



CC Series
Couplers



COMTELCO ANTENNAS

A Family Brand of Mobile Mark

Complete Wireless Antenna SOLUTIONS

MARINE ANTENNAS

Marine Antennas, 250 watt

MS150U-XXX	144-225MHz Unity Gain 64"
MS450U-XXX	406-512MHz 3dBd Gain 32"
MS450XL3-XXX	406-512MHz 3dBd Gain 36"
MS800XL3WB	806-930MHz 3dBd Gain 38"

XXX Refers to center required, Specify connector at time of order

2.4GHZ XL Series Marine Antennas, 100 watt

MS2400XL3	2400-2500MHz 5dBi Gain 18"
MS2400XL6	2400-2500MHz 8dBi Gain 24"

800 / 1800MHz Cell / PCS 3dB

MSDB18U8	825-896 1850-1990MHz 24"
----------	--------------------------

Marine Antennas, 100 watt

MS800SA	806-866MHz 3dBd Gain 27"
MS800SC	825-896MHz 3dBd Gain 27"
MS800SE	894-944MHz 3dBd Gain 27"

MOUNTS

Marine Mounts

M1034A	Lexan
M1034B	Stainless Steel

All marine mounts mate with standard 1" 14 thread mount for fast installation.



BSM800U

MS2400XL3



OMNI BASE | MARINE

PANEL ANTENNAS

Mounting Styles

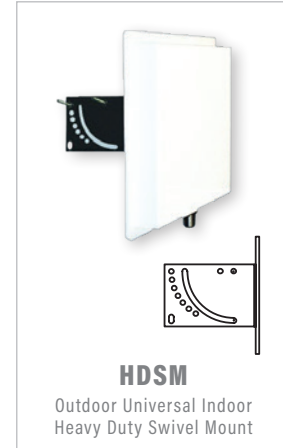

Panel antennas have become popular as alternatives to higher gain directional antennas such as yagis. They focus a signal to a particular area and can be designed to allow for maximum adjustment in a relatively attractive package.

Design techniques for manufacturing these antennas vary considerably. Excellent performance is obtained by using printed circuit board technology and in some instances, stamped and formed patch elements.

Most of our panels are designed for outdoor use. Indoor applications require a less robust design without regard for common corrosion, moisture and ultraviolet damage. Our standard panels feature epoxy powder-coated aluminum mounting plates. The ability to completely adjust for any angle of radiation usually depends on the mount system used.

Gain is generally dependent on the element configuration of the panel. Number of elements will impact both the gain and the pattern that results when using a given antenna.

As with all Comtelco brand antennas, radiation specifications are available upon request or as a PDF file at www.mobilemark.com.

Our lineup of panel antenna is constantly being expanded.

All B26 Series Panels are ¾" Deep and are supplied with a 12" Teflon® Pigtail.

900 MHz, 8 ½" x 8 ½" Panel, 7.5dBi

B2697	900-930MHz Slip mount
B2697SM	900-930MHz Swivel mount

Horizontal Beamwidth 65 Deg
Vertical Beamwidth 65 Deg

2.4GHz, 8 ½" x 8 ½" Panel, 14dBi

B262414V	2.4-2.5GHz V bolts & V blocks
B262414HDSM	2.4-2.5GHz Heavy duty Swivel mount

Horizontal Beamwidth 35 Deg
Vertical Beamwidth 35 Deg

2.4GHz, 12 ½" x 12 ½" Panel, 17.5dBi

B262418V	2.4-2.5GHz V bolts & V blocks
B262418HDSM	2.4-2.5GHz Heavy duty Swivel mount

Horizontal Beamwidth 25 Deg
Vertical Beamwidth 25 Deg

If a given configuration is not shown please don't hesitate to contact us to see if we can come up with a solution for your requirement.

All B36 Series Panels are 1½" Deep and are supplied with a Direct Female "N" Termination.

2.4GHz, 4 ½" x 4 ½" Panel, 7.5dBi

B36247	2.4-2.5GHz Slip mount
B36247V	2.4-2.5GHz V bolts & V blocks
B36247HDSM	2.4-2.5GHz Heavy duty Swivel mount

Horizontal Beamwidth 50 Deg
Vertical Beamwidth 65 Deg

2.4GHz, 12 ½" x 12 ½" Panel, 18dBi

B362418	2.4-2.5GHz Slip mount
B362418V	2.4-2.5GHz V bolts & V blocks
B362418HDSM	2.4-2.5GHz Heavy duty Swivel mount

Horizontal Beamwidth 25 Deg
Vertical Beamwidth 25 Deg

Dual Band Panel, 8 ½" x 8 ½" 1 ¾" deep, 12" Teflon® Pigtail, 7.5dBi

B37621HDSM	698-930/1710-2100MHz Heavy duty Swivel mount
------------	--



PREMIUM COLD WELD YAGI ANTENNAS FOR SUPERIOR PERFORMANCE AND VALUE

Our Yagi antennas are used by customers all over the world. They are used in the oil industry for off shore drilling rigs and in locations where resistance to severe environments is a great cause of concern. They are used by telecom carriers that demand total reliability. Since 1978 Comtelco (now a Mobile Mark brand) has shipped over 100,000 yagis worldwide.

By using a construction technique called cold weld, we can produce antennas that are every bit as rugged as a standard welded yagi, but at a significant cost advantage. Using specially designed hydraulic machinery, we are able to press tight tolerance solid elements into precision-machined booms. These elements are pressed in with over 1,000 lbs. of hydraulic pressure insuring a permanent bond. After assembly, an epoxy powder coat is applied. This seals the antenna, providing total environmental protection.

Our basic yagi design is common to both our standard duty and heavy-duty versions. The standard duty "22 series" yagis are built using 1/2" U channel booms with 1/4" solid elements. The heavy-duty "33 series" yagis use 1" U channel booms with 3/8" solid elements. Both series have a no-tune balun assembly and epoxy powder-coated finish.

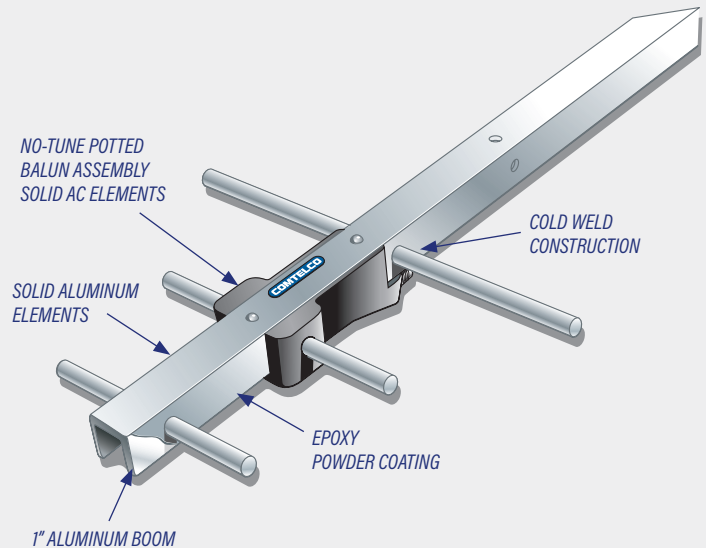

- Stainless steel mounting hardware
- 300 watt power rating
- 125 MPH wind survival rating

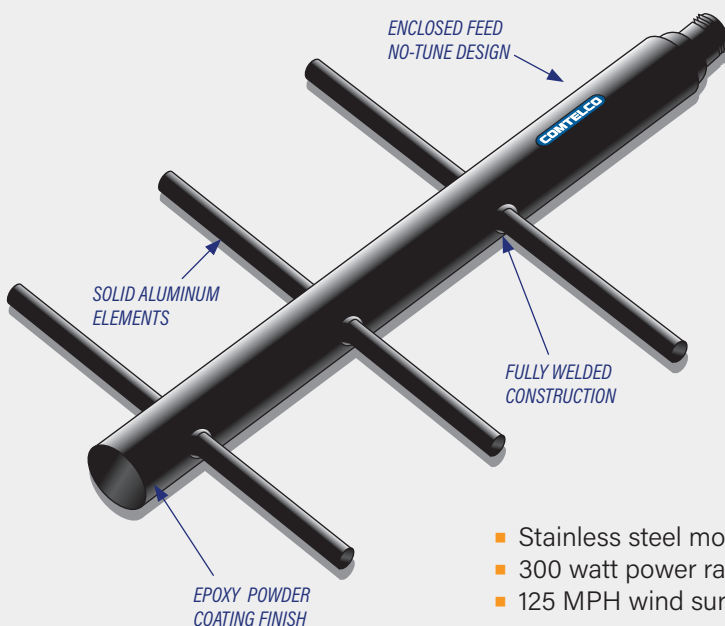

FULLY WELDED ENCLOSED FEED YAGIS

When a fully welded Yagi with an enclosed feed is required, the Y66 series will fill the need. These antennas are available in standard and log periodic versions. They feature the same solid elements as our heavy duty Y33 series yagis. These yagis have been designed to meet the rigid requirements of the positive train control system.

- Stainless steel mounting hardware
- 300 watt power rating
- 125 MPH wind survival rating



ANTENNAS, MOUNTS

YDM1	Double Mount Kit 1 Block
YDM2	Double Mount Kit 2 Blocks
YSTB33	Yagi Swivel Tilt Bracket Optional VB01

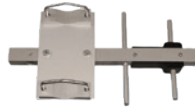

YDM2

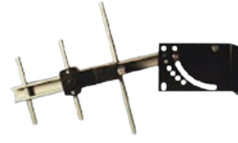

YSTB33

HEAVY DUTY YAGI ANTENNAS 144/225MHz

Letter before dash: C = S0239, A = Type N.

VHF 5 element, 9dBd

Y3315C-A	144-148MHz
Y3315C-B	150-156MHz
Y3315C-C	156-162MHz
Y3315C-D	162-168MHz
Y3315C-E	168-174MHz

Light assembly required. These antennas have an anodized finish. UHF connector standard.



Y3315C

VHF 3 element, 6dBd, welded

Y3313C-A	144-148MHz
Y3313C-B	150-156MHz
Y3313C-C	156-162MHz
Y3313C-D	162-168MHz
Y3313C-E	168-174MHz
Y3323C-B	210-225MHz

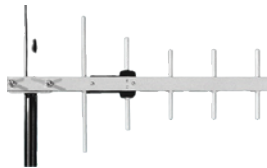

Y3385D

VHF 5 element, 9dBd, welded

Y3325C-B	210-225MHz
----------	------------

Welded series yagis are shipped assembled and are polyester coated.

- 1" aluminum boom with 3/8" solid elements
- Elastomeric thermoplastic sealed balun connections
- Cold weld construction, Epoxy powder coated surfaces
- No-Tune Direct balun N female connection
- Stainless steel mounting hardware fits 2 3/8" mast
- 300 watt power rating, 125 MPH wind survival rating

HEAVY DUTY YAGI ANTENNAS UHF, 800/900 MHz

UHF 3 element, 7dBd

Y3343D-A	406-430MHz
Y3343D-B	430-450MHz
Y3343D-C	450-470MHz
Y3343D-D	470-490MHz
Y3343D-E	490-512MHz

UHF 5 element, 9dBd

Y3335D-D	370-390MHz
Y3345D-A	406-430MHz
Y3345D-B	430-450MHz
Y3345D-C	450-470MHz
Y3345D-D	470-490MHz
Y3345D-E	490-512MHz

UHF 7 element, 10dBd

Y3347D-A	406-430MHz
Y3347D-B	430-450MHz
Y3347D-C	450-470MHz
Y3347D-D	470-490MHz
Y3347D-E	490-512MHz

UHF Stacked, 13dBd, Kit

Includes 2-Y3347 & CC450 Coupler / Stacker

2Y3347CC-A	406-430MHz
2Y3347CC-B	430-450MHz
2Y3347CC-C	450-470MHz
2Y3347CC-D	470-490MHz
2Y3347CC-E	490-512MHz

UHF 12 element, 12dBd

Y33412D-A	406-430MHz
Y33412D-B	430-450MHz
Y33412D-C	450-470MHz
Y33412D-D	470-490MHz
Y33412D-E	490-512MHz

"N" female termination standard, TNC & PIGTAIL versions available on UHF and 800MHz heavy duty yagis.

700/900MHz 3 element, 6dBd

Y3373-WB	698-960MHz
----------	------------

800/900MHz 5 element, 9dBd

Y3385D-06	806-896MHz
Y3385D-66	866-960MHz

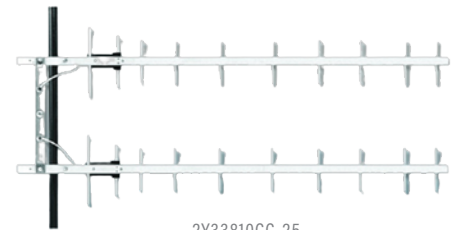

2Y33810CC-25

800/900MHz 7 element, 10dbd

Y3387D-06	806-896MHz
Y3387D-66	866-960MHz
Y3387D-915	900-930MHz

800/900MHz 10 element, 12dBd

Y33810D-06	806-866MHz
Y33810D-25	825-896MHz
Y33810D-96	896-960MHz
Y33810D-915	900-930MHz

900MHz 15 element, 13dBd

Y33915D-915	900-930MHz
-------------	------------

800/900MHz Stacked, 15dBd, Kit

Includes 2-Y33810 & CC850 Coupler / Stacker

2Y33810CC-06	806-866MHz
2Y33810CC-25	825-896MHz
2Y33810CC-96	896-960MHz
2Y33810CC-915	900-930MHz

"N" female termination standard, TNC & PIGTAIL versions available on UHF and 800MHz heavy duty yagis.





Engineering Excellence

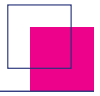

YAGI

FULLY WELDED AND ENCLOSED FEED YAGI ANTENNAS

Fully Welded Yagi with Enclosed End Feed

Y6623D	200-225MHz, 7dBd
Y6625D	200-225MHz, 8.6dBd
Y6633D	322-339MHz, 7dBd
Y6636D-370	370-400MHz, 7dBd
Y6646D-A	400-460MHz, 9.5dBd
Y6646D-B	425-485MHz, 9.5dBd
Y6687D698	698-870MHz, 10dBd
Y6687D745	745-896MHz, 10dBd
Y6687D890	890-960MHz, 10dBd
Y6687D915	900-930MHz, 10dBd

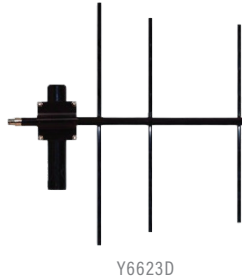

- Elastomeric thermoplastic sealed balun connections
- Cold weld construction, Epoxy powder coated surfaces
- No-Tune Direct balun N female connection
- Stainless steel mounting hardware fits 2 3/8" mast
- 300 watt power rating, 125MPH wind survival rating



Wideband Log Periodic Antennas

Y42400WB	400-800MHz Pigtail "N" Enclosed Feed
Y42700WB	600-6000 MHz Pigtail "N" Enclosed Feed
Y42700WB-2X	Two Y42700WB for 2xMIMO, 600-6000MHz

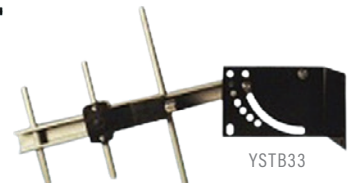
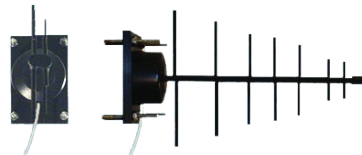

Yagi Antenna Accessories

VB01	V-Bolt & Block Assembly
YDM1	Double Mount Kit 1 Block
YDM2	Double Mount Kit 2 Blocks
YSTB22	Yagi Swivel Tilt Bracket Optional VB01
YSTB33	Yagi Swivel Tilt Bracket Optional VB01
BKT1	Mast Mount for CC Series Power Divider
BKT2	Mast Mount for 66 Series Yagi and EDX

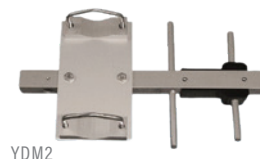
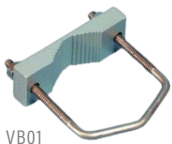

COMTELCO – THE LEADER IN SPRING LOADED ANTENNAS

Comtelco introduced the first spring loaded-contact in a mobile antenna and continues to develop and improve this technology.

Comtelco antennas use a rugged .125" diameter stainless 17-7 steel tapered whip in our standard base loaded antennas. Many of our competitors use only a .100" diameter whip. The difference can be seen in the bending over that a lighter duty whip exhibits when mounted on a moving vehicle.

Our antennas have an enclosed silver-plated phasing coil and feature a .125" diameter stainless whip below the coil. This gives us a more robust whip than units with only a .100" diameter whip.

Our High-Q loading coils are wound and 100% tested before and after assembly to insure proper operation. Our coils are larger diameter allowing Low Band coils to be built in the same low profile base as our VHF and UHF models. We have provided more frequency splits in our shunt fed base loads. This allows better frequency matching throughout the bandwidth.

Most of our black whips are epoxy powder coated so there is no chipping or flaking, a problem that is encountered with chrome.



LOW BAND BASE LOADS

Low Band Unity Gain, Shunt Fed, DC Grounded, Brite finish

A1801AH-27	26-31MHz
A1801AH-30	30-35MHz
A1801AH-34	32-37MHz
A1801AH-37	36-40MHz
A1801AH-39	39-45MHz
A1801AH-45	45-54MHz
A1801AH-47	47-54MHz

To order shock spring version add "S" suffix to the base part number. EXAMPLE: A1801AHS-27

Low Band Unity Gain, Shunt Fed, DC Grounded, Black finish

A1801BH-27	26-31MHz
A1801BH-30	30-35MHz
A1801BH-34	32-37MHz
A1801BH-37	36-40MHz
A1801BH-39	39-45MHz
A1801BH-45	45-54MHz
A1801BH-47	46-54MHz

To order shock spring version add "S" suffix to the base part number. EXAMPLE: A1801BHS-27

Low Band Unity Gain, Series Fed, Brite finish

A1801A-27	27-31MHz
A1801A-30	30-35MHz
A1801A-34	34-40MHz
A1801A-40	40-48MHz
A1801A-47	47-54MHz

To order shock spring version add "S" suffix to the base part number. EXAMPLE: A1801AS-27

Low Band Unity Gain, Series Fed, Black finish

A1801B-27	27-31MHz
A1801B-30	30-35MHz
A1801B-34	34-40MHz
A1801B-40	40-48MHz
A1801B-47	47-54MHz

To order shock spring version add "S" suffix to the base part number. EXAMPLE: A1801BS-27

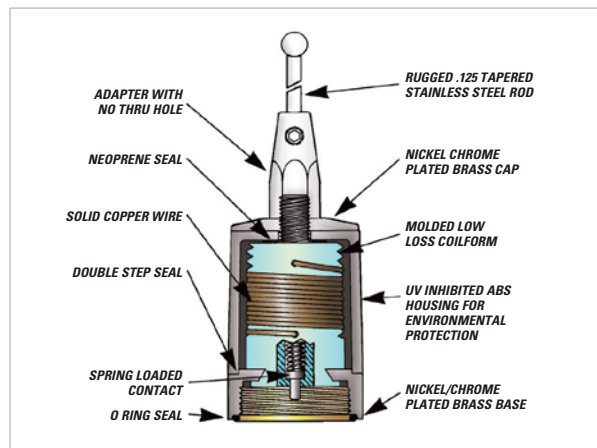

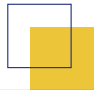

VHF, UHF, 800MHz, BASE LOADS

VHF 3dBd Gain, 5/8 Wave, Brite finish

A1813A-32	132-174MHz
A1813A-44	144-174MHz
A1823A-00	200-250MHz
A1823A-50	250-280MHz

VHF 3dBd Gain, 5/8 Wave, Black finish

A1813B-32	132-174MHz
A1813B-44	144-174MHz
A1823B-00	200-250MHz
A1823B-50	250-280MHz

VHF 1/2 Wave, No Ground Plane, Brite finish

A1812A-44	144-174MHz
A1822A-00	200-225MHz

VHF 1/2 Wave, No Ground Plane, Black finish

A1812B-44	144-174MHz
A1822B-00	200-225MHz

UHF 3dBd Gain, 5/8 Wave, Brite finish

A1843A-06	406-430MHz
A1843A-30	430-450MHz
A1843A-50	450-470MHz
A1843A-70	470-490MHz
A1843A-90	490-512MHz

UHF 3dBd Gain, 5/8 Wave, Black finish

A1843B-06	406-430MHz
A1843B-30	430-450MHz
A1843B-50	450-470MHz
A1843B-70	470-490MHz
A1843B-90	490-512MHz

To order shock spring version add "S" suffix to the base part number. EXAMPLE: A1813AS-32

UHF 5dB Gain, 5/8 Wave over 5/8 Wave, Brite finish

A1845A-06	406-430MHz
A1845A-30	430-450MHz
A1845A-50	450-470MHz
A1845A-70	470-490MHz
A1845A-90	490-512MHz

UHF 5dB Gain, 5/8 Wave over 5/8 Wave, Black finish

A1845B-06	406-430MHz
A1845B-30	430-450MHz
A1845B-50	450-470MHz
A1845B-70	470-490MHz
A1845B-90	490-512MHz

UHF 1/2 Wave, No Ground Plane, Brite finish

A1842A-06	406-430MHz
A1842A-30	430-450MHz
A1842A-50	450-470MHz
A1842A-70	470-490MHz
A1842A-90	490-512MHz

UHF 1/2 Wave, No Ground Plane, Black finish

A1842B-06	406-430MHz
A1842B-30	430-450MHz
A1842B-50	450-470MHz
A1842B-70	470-490MHz
A1842B-90	490-512MHz

800/900MHz, Brite finish

A1885A-06	806-866MHz
A1885A-96	896-960MHz
A1885A-915	900-930MHz

800/900MHz, Black finish

A1885B-06	806-866MHz
A1885B-96	896-960MHz
A1885B-915	900-930MHz

A1855 not available with shock spring, use A1585.

QUARTER WAVE ANTENNAS 54MHz TO 970MHz

See ordering chart for frequency suffix.

Quarterwave, Brite finish

A1111A 108-970MHz	3/4" M Type .100 Whip Spring Loaded Contact
A1211AC 118-970MHz	3/4" M Type .062 Whip Brass Contact Must specify frequency
A1911A 136-970MHz	L Stud Mount .100 Whip
A2111A 108-970MHz	Integrated Magnet Mount 12ft LL-195 TNC or PL259
A1501A 54-132MHz	Shock Spring, 6MHz Bandwidth at 54MHz 20MHz Bandwidth at 100MHz
A1511A 132-970MHz	Shock Spring, 24MHz Bandwidth at VHF 100MHz Bandwidth at UHF
A1511AAC 118-138MHz	Shock Spring, Full Band Coverage 100MHz Bandwidth at UHF

Quarterwave, Black finish

A1111B 108-970MHz	3/4" M Type .100 Whip Spring Loaded Contact
A1211BC 118-970MHz	3/4" M Type .062 Whip Brass Contact Must specify frequency

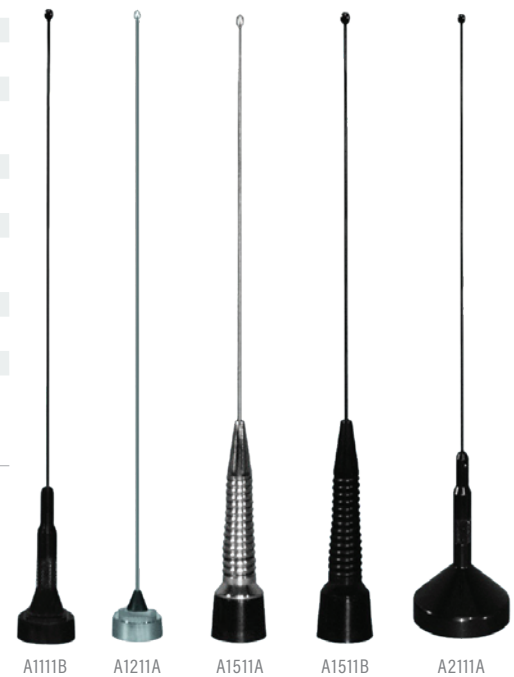

A1911B 136-970MHz	L Stud Mount .100 Whip
A2111B 108-970MHz	Integrated Magnet Mount 12ft LL-195 TNC or PL259
A1501B 54-132MHz	Shock Spring, 6MHz Bandwidth at 54MHz 20MHz Bandwidth at 100MHz
A1511B 132-970MHz	Shock Spring, 24MHz Bandwidth at VHF 100MHz Bandwidth at UHF
A1511BAC 118-138MHz	Shock Spring, Full Band Coverage 100MHz Bandwidth at UHF

Ordering Chart for Specific Frequency Antennas

-108: 108-125MHz	-152: 152-162MHz	-450: 450-470MHz
-125: 125-132MHz	-162: 162-174MHz	-470: 470-490MHz
-132: 132-138MHz	-220: 220-225MHz	-490: 490-512MHz
-136: 136-144MHz	-406: 406-430MHz	-800: 800-896MHz
-144: 144-152MHz	-430: 430-450MHz	-896: 896-960MHz

Reliable Business Partnerships



3-3.5dBd MOBILE GAIN ANTENNAS 430MHz THROUGH 970MHz

UHF 3dB Gain, Wide Band, 380-512,
No Tune

A15HD450WB 380-512MHz 3dBd Wide Band

UHF 3dBd Gain, Closed Coil, Brite finish

A1145A-06 406-450MHz
Spring Loaded Contact

A1145A-50 450-470MHz
Spring Loaded Contact

A1145A-70 470-512MHz
Spring Loaded Contact

A2145A-06 406-450MHz Integrated
Magnet Mount

A2145A-50 450-470MHz Integrated
Magnet Mount

A2145A-70 470-512MHz Integrated
Magnet Mount

UHF 3.5dBd Gain, Closed Coil, Black finish

A1145B-06 406-450MHz
Spring Loaded Contact

A1145B-50 450-470MHz
Spring Loaded Contact

A1145B-70 470-512MHz
Spring Loaded Contact

A2145B-06 406-450MHz Integrated
Magnet Mount

A2145B-50 450-470MHz Integrated
Magnet Mount

A2145B-70 470-512MHz Integrated
Magnet Mount

698/2700MHz 3dBd Wide Band, Brite finish

A15WB698B 698-2700MHz Wide Band Mobile

A21WB698B 698-2700MHz Integrated Magnet Mount

740/900MHz 3dB Gain, Brite finish

A1083B-96 896-940MHz
Spring Loaded Contact

A1173B-74 740-800MHz Open Coil .100 Whip

A1173BS-74 740-870MHz Shock Spring

A1183B-06 806-866MHz 3/4" M Type

A1183B-24 824-896MHz Open Coil .100 Whip

A1183B-87 870-960MHz Spring Loaded Contact

A1283B-06 806-866MHz 3/4" M Type

A1283B-24 824-896MHz Open Coil

A1283B-87 870-960MHz Flexible .062 Whip

A1483B-06 806-866MHz 3/4" M Type

A1483B-24 824-896MHz Open Coil .100 Whip

A1483B-87 870-960MHz Spring Loaded Contact

A2183B-06 806-866MHz Integrated
Magnet Mount

A2183B-24 824-896MHz Open Coil

A2183B-87 870-960MHz 12f Coax

- Must specify connector for all integrated magnet mounts on this page. Additional charge may apply.
- Model A1143 works from 430 through 490MHz with no cutting or tuning necessary.

A1145A
A2145B
A15HD450W



A15WB698 A1183B A1283B A1483A A1173AS A2183B A1083B





3.5dBd MOBILE GAIN ANTENNAS 735MHz THROUGH 1GHz

740/900MHz 3.5dBd Gain, Brite finish

A1175A	740-800MHz
A1175AS	740-870MHz LD Shock Spring
A1185A-24	824-896MHz 3/4" M Type
A1185A-87	870-960MHz Closed Coil
A1185A-90	900-930MHz Spring Loaded Contact
A1575A-74	740-840MHz
A1575A-76	764-870MHz
A1585A-87	870-960MHz Closed Coil Shock Spring
A2185A-06	806-866MHz
A2185A-24	824-896MHz Integrated Magnet Mount
A2185A-87	870-960MHz 12ft LL-195 Coax
A2185A-90	900-930MHz TNC, UHF or N

740/900MHz 3.5dBd Gain, Black finish

A1175B	740-800MHz
A1175BS	740-870MHz LD Shock Spring
A1185B-24	824-896MHz 3/4" M Type
A1185B-87	870-960MHz Closed Coil
A1185B-90	900-930MHz Spring Loaded Contact
A1575B-74	740-840MHz
A1585B-76	764-870MHz
A1585B-87	870-960MHz Closed Coil Shock Spring
A2185B-06	806-866MHz
A2185B-24	824-896MHz Integrated Magnet Mount
A2185B-87	870-960MHz 12ft LL-195 Coax
A2185B-90	900-930MHz TNC, UHF or N

800/900MHz 5dBd Gain, Brite finish

A11855A-24	824-896MHz 3/4" M Type
A11855A-96	870-960MHz Closed Coil
A11855A-90	900-930MHz Spring Loaded Contact
A21855A-24	824-896MHz Integrated Magnet Mount
A21855A-87	870-960MHz 12ft LL-195 Coax
A21855A-90	900-930MHz TNC, UHF or N

800/900MHz 5dBd Gain, Black finish

A11855B-24	824-896MHz 3/4" M Type
A11855B-96	870-960MHz Closed Coil
A11855B-90	900-930MHz Spring Loaded Contact
A21855B-24	824-896MHz Integrated Magnet Mount
A21855B-87	870-960MHz 12ft LL-195 Coax
A21855B-90	900-930MHz TNC, UHF or N



A1185A A1175AS A1585A A2185B A1575B A11855A

Mobile Gain Antennas, 2.4GHz

2.4GHz 5dBi Gain, Integrated Magnet Mount, Black finish

A212405B	2.4-2.5GHz 12ft Micro Loss Coax, TNC
----------	--------------------------------------

2.4GHz Elevated Feed 5dBi Gain, Black finish

A10245B	2.4-2.5GHz Enclosed Elements 14" Long
---------	---------------------------------------



A10245



A31245

To Order Mobile Antennas:

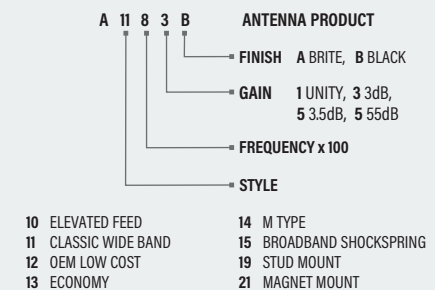

EXAMPLE: A1183A CAL-02

ADD: MOUNT, CABLE & CONNECTOR
(SEE MOUNT PAGE)

MULTI-BAND MOBILE ANTENNAS



A1131A A1132B A1531A



A2131A A11331A A55136TB



DBD1 DBD3



A18H31B A1510WTB A1833B

Dual Band 6 meter / 2 meter Unity, Brite finish

A18H31A 50-54 / 144-148MHz Base Loaded .125 whip

Dual Band 6 meter / 2 meter Unity, Black finish

A18H31B 50-54 / 144-148MHz Base Loaded .100 whip

Dual Band VHF Unity, UHF 2.5dB, Brite finish

A1131A 140-170 / 440-470MHz Open Coil .100 Whip

A1132A 140-170 / 440-470MHz Closed Coil .100 Whip

A1531A 140-170 / 440-470MHz Closed Coil Shock Spring

A2131A 140-170 / 440-470MHz Integrated Magnet Mount

Dual Band VHF Unity, UHF 2.5dB, Black finish

A1131B 140-170 / 440-470MHz Open Coil .100 whip

A1132B 140-170 / 440-470MHz Closed Coil .100 Whip

A1531B 140-170 / 440-470MHz Closed Coil Shock Spring

A2131B 140-170 / 440-470MHz Integrated Magnet Mount

Dual Band VHF 2.5dB, UHF 4.5dB, Brite finish

A1833A-40 140-150 / 440-450MHz

A1833A-50 150-160 / 450-460MHz Closed Coil .100 Whip

A1833A-60 160-170 / 460-470MHz Spring Loaded Contact

Dual Band VHF 2.5dB, UHF 4.5dB, Black finish

A1833B-40 140-150 / 440-450MHz

A1833B-50 150-160 / 450-460MHz Closed Coil .100 Whip

A1833B-60 160-170 / 460-470MHz Spring Loaded Contact

Tri Band 3dB Gain VHF, UHF, 800MHz, Black finish

A55136TB, TBS 136-174 / 380-490 / 698-870 MHz

Tri Band Unity Gain VHF, UHF, 800MHz, Brite finish

A11331A-X 144-160 / 435-460 / 885-970MHz

A11331A-Y 150-165 / 450-470 / 806-940MHz

A11331A-Z 150-174 / 450-475 / 825-896MHz

Tri Band Unity Gain VHF, UHF, 800MHz Black finish

A11331B-X 144-160 / 435-460 / 885-970MHz

A11331B-Y 150-165 / 450-470 / 806-940MHz

A11331B-Z 150-174 / 450-475 / 825-896MHz

Wide Tri Band 140-170, 450-490, 730-800MHz, Black finish

A1510WTB No Tuning, Works Across all bands noted above

2dB Gain Cell / PCS, 800 / 1900 4" Tall, Black finish

A158192B 698-960 / 1850-2200MHz

Dual Band 3dB Gain Cell / PCS, ABS, 4 3/4" Dia. Radome

A25382B,W 806-940 / 1850-1970MHz

Dual Band 2dB Gain 900 / 2400MHz, 3" Tall, Black finish

A159242B 900-930 / 2300-2500MHz

Dual Band Multi-Use 1" Diameter x 4" ABS, Black finish

A46DB630B,W 698-980 / 1800-2200MHz

A11382B 806-940 / 1710-1970MHz

A113249B 880-1200 / 2300-2600MHz

A1132408B 806-940 / 1850-2250MHz

A1132412B 1100-1500 / 2400-2800MHz

A1132414B 1200-1600 / 2400-2800MHz

VHF/UHF DIPLEXER

Dual Band VHF / UHF Diplexer

DBD1 140-174 / 440-512MHz

VHF/UHF/800 TRIPLEXER

Dual Band VHF / UHF Triplexer

DBD3 144-174, 406-512, 745-870MHz





LOW PROFILE ANTENNAS

VHF Low Profile 3" Dia. 3 1/4" High, Mobile NMO

A1611B,W	Must provide center frequency between 150-174MHz
A1621B,W-220	220-222MHz
A1621B,W-222	222-224MHz
A1621B,W-224	224-226MHz

VHF Low Profile 3" Dia. 3 1/4" High, Tamperproof Ground Plane not included

A1611BN,WN	Must provide center frequency between 150-174MHz
A1621BN,WN-220	220-222MHz
A1621BN,WN-222	222-224MHz
A1621BN,WN-224	224-226MHz

46 Style Low Profile 1" Dia. Mobile NMO

A4641B,W-406	406-420MHz	2.7"
A4641B,W-420	420-435MHz	2.7"
A4641B,W-440	440-450MHz	2.7"
A4641B,W-450	450-465MHz	2.7"
A4641B,W-465	465-480MHz	2.7"
A4641B,W-480	480-495MHz	2.7"
A4641B,W-490	490-512MHz	2.7"
A4671B,W-750	746-796MHz	2.7"
A4681B,W-806	806-896MHz	2.7"
A4681B,W-896	896-960MHz	2.7"
A4681B,W-915	900-930MHz	2.7"
A46192B,W	1.85-1.99GHz	2.7"
A46245B,W	2.4-2.5GHz	2"
A46450WBB	Low Profile Wide Band 440 512MHz, Black	
A46450WBBN	Low Profile Wide Band 440 512MHz, Black (Tamperproof)	

Radome 4.25" Dia. x 1.5" NMO

A2543B,W	See ordering chart for frequency
A56450B,W	See ordering chart for frequency
A25764B,W	764-869MHz
A2582B,W	806-940MHz

Dual Band Mobile

A46DB630B,W	698-980/1800-2200MHz
A158192B,W	750-960/1850-2200MHz
A1132408B,W	806-940/1850-2250MHz
A11382B,W	806-940/1710-1970MHz
A25382B,W	806-940/1850-1990MHz
A113249B,W	880-1200/2300-2600MHz
A159242B,W	900-930/2400-2500MHz
A1132412B,W	1100-1500/2400-2500MHz
A1132414B,W	1200-1600/2400-2800MHz
A46DB2458B,W	1.5-2.7/4.5-6.0GHz

Unity Gain Mobile Bullet

A15698B	698-960MHz
---------	------------

Wide Band Mobile Unity Gain

A1510B470	470-698MHz
-----------	------------

Dual Band Tamperproof

Ground Plane not included	
A46DB630BN,WN	698-980MHz/1.8-2.2GHz
A25382BN,WN	806-940MHz/1.85-1.99GHz
A46DB818BN,WN	806-960MHz/1.85-1.99GHz
A46DB2458BN,WN	1.5-2.7/4.5-6.0GHz

Radome 4.25" Dia. x 1.5" Tamperproof

Ground Plane not included	
A2543BN,WN	See ordering chart for frequency
A2582BN, WN	806-940MHz



A1611WN

- No power limiting PC Boards!
- Proven design used by the military since World War II (1941)



A1611W



A46245B,W

A4681B,W

A4681B,W

- All 46 Style Low Profiles available in Tamperproof version.
- All 46 Style Low Profiles now available in 380-400MHz.



A158192B, A15698B

A1510B470

A11382B

A159242B

A113249B



A2582B, A25764B

A2543W, A25764W

A2582WN

A2543BN

Ordering Chart for A56450 Antennas

-450: 450-460MHz	-480: 480-490MHz
-460: 460-470MHz	-490: 490-500MHz
-470: 470-480MHz	-500: 500-512MHz

Ordering Chart for A2543, B2543 Antennas

-450: 450-470MHz	-490: 490-512MHz
-470: 470-490MHz	

BROAD BAND WIRELESS

Tamperproof antenna part numbers starting with a B include a ground plane. This allows for installation into ceiling tiles or other applications that do not provide sufficient ground planes.

Ceiling Mount Antennas

B1611WN	Tamperproof N Type 13" GP Must provide center frequency between 150-174MHz
B4641WN-406	Tamperproof N Type 406-410MHz with 13" GP
B4641WN-410	Tamperproof N Type 410-415MHz with 13" GP
B4641WN-415	Tamperproof N Type 415-420MHz with 13" GP
B4641WN-420	Tamperproof N Type 420-425MHz with 13" GP
B4641WN-425	Tamperproof N Type 425-430MHz with 13" GP
B4641WN-430	Tamperproof N Type 430-450MHz with 13" GP
B4641WN-450	Tamperproof N Type 450-470MHz with 13" GP
B4641WN-470	Tamperproof N Type 470-490MHz with 13" GP
B46DB2458WN	Tamperproof N Type 1.5-2.7/4.5-6.0GHz with
B46DB630WN	Tamperproof N Type 698-980MHz/1.8-2.2GHz with 3" GP
B46DB818WN	Tamperproof N Type 806-960/1850-1990MHz 8" with GP

All the above antennas are white, for black versions replace the W with a B.

B2543WN,BN	Ceiling Mount - See ordering chart for frequency pg. 16
B25382WN,BN	Ceiling Mount 806-940/1850-1970MHz



COUPLERS, STACKERS & SPECIALTY ANTENNAS

Couplers / Stackers, Misc

CC150-2	150-250MHz	2 port
CC220-2	200-550MHz	2 port
RC220-2	200-400MHz	2 port
TC220-3	200-400MHz	3 port
CC450-2	400-512MHz	2 port
CC450-3	400-512MHz	3 port
CC850-2	800-970MHz	2 port
QC850	800-970MHz	4 port

Truck Mirror Mount Antennas

BSMN	Mirror Mount NMO "N" Connector
------	--------------------------------

Pipe Mount Low Profile

B46915B	WNM 900-930MHz 1" 14 THD Low Pro "N"
---------	---

Surge & Lightning Arrestor Products

All standard connectors are "N" Female to "N" Female.

CAG-50	NFN 50MHz-700MHz Gas Tube, DC Blocked
CPG-0N1NF	DC-3GHz Gas Tube, DC Pass, Bulkhead
CSF-2000NFNF	2GHz-3GHz Filter, DC Blocked
GT350	350 Volt Gas Tube Replacement

CB Antenna

CB1800	Hi Performance CB with Weather Option
--------	---------------------------------------

Aircraft Mobile, Extended Coverage

A1511AAC	118MHz-138MHz White Whip
A1511BAC	118MHz-138MHz Black Whip



QC850

The QC850 works great for connecting multiple cell phones to one antenna.



TC220-3



CC450
CC850



B46915WNM

Pipe mountable low profile 1" 14 THD

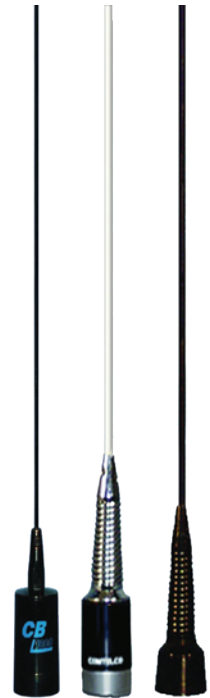

CB1800, A1812MC, A1511BAC

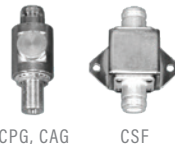

CPG, CAG

CSF





MOUNT SYSTEMS FOR STANDARD AND VERY LOW LOSS REQUIREMENTS

Selection of proper cable kits and mount types has become more important as we have moved up the frequency band. Very high losses and noise in a cable kit will greatly affect the performance of all systems. This is more of a problem above the UHF band.

A LL-195 cable exhibits a loss of 11 dBd per 100 feet at 900MHz. This means that the loss in a standard 17 foot cable is 1.82 dBd. At higher frequencies the losses are even greater.

Another source of loss is in the mount itself. The NMO type mount was developed for mobile radio installation when most services operated in the 30-50MHz range. Loss was not much of a factor at those frequencies. Today many of our systems operate well into the GHz range where loss is a big deal.

Advances have been made such as using all brass mounts to avoid corrosion but this has its drawbacks because brass is soft. If not handled carefully, a brass mount can bend or even break during installation. Its softness also affects its ability to pierce other metals during installation causing a less than perfect ground connection.

A final consideration with regard to NMO type mounts in general is the tendency for cross threading when installing an antenna because of the flats in the standard mount.

In an attempt to counteract many of these problems we patented an all brass mount with no flats, and a stainless steel piercing saddle to provide a good electrical and mechanical connection.

We developed a new technique for shielding the feed point of this mount to provide a better constant impedance low loss assembly.

We will continue to support our legacy standard mounts, including the high distributive capacity (big button) versions while being inspired design the next GEN products for even tougher applications.



C NMO TYPE MOUNT KIT

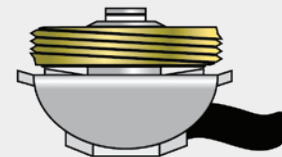

CE NMO TYPE MOUNT KIT

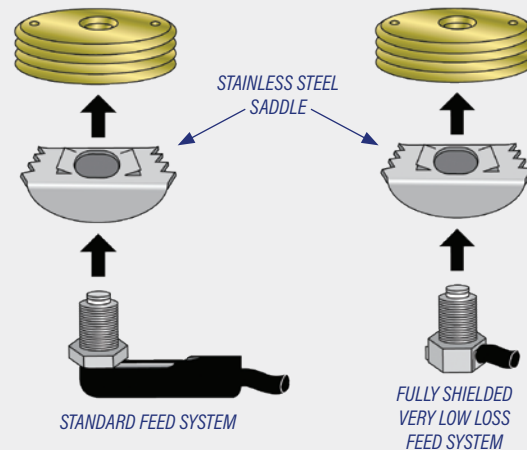

STANDARD FEED SYSTEM

FULLY SHIELDED
VERY LOW LOSS
FEED SYSTEM



C TYPE
All Brass
3/8"-3/4" Hole

MB TYPE
All Brass
3/4" Hole

MH TYPE
Standard
Hi Dist Cap

MHB TYPE
All Brass
Hi Dist Cap

PERMANENT BODY MOUNTS

Permanent Body Mounts No Cable or Connector

C	All Brass	3/4"-3/8" Mount Only
M	Standard	3/4" Mount Only
MB	All Brass	3/4" Mount Only
MH	Standard	3/4" Mount Only (Large Contact)
MHB	All Brass	3/4" Mount Only (Large Contact)

The above mounts are supplied complete with plastic insulator for LL-195 cable.

The H mounts have a large contact for use in applications that require increased distributed capacity.

- All brass mounts provide better corrosion resistance than standard steel mounts.
- All mount assemblies are 100% tested.
- Standard mount assemblies are supplied with loose connector.
- Mount assemblies can be supplied with connector installed upon request.
- Non-standard cable lengths are available upon request.

Mounts with 17' of GR58A/U Stranded Center or LL-195U Stranded Center Cable

CAL	C Mount No Connector
MAL	M Mount No Connector
MBAL	MB Mount No Connector

Mounts with 17' of LL-195 Cable

CZL	C Mount No Connector
MZL	M Mount No Connector
MBZL	MB Mount No Connector
CZL-01	C Mount Crimp TNC
MZL-01	M Mount Crimp TNC
MBZL-01	MBXL-01 MB Mount Crimp TNC
CZL-02	C Mount Crimp BNC
MZL-02	M Mount Crimp BNC
MBZL-02	MB Mount Crimp BNC
CZL-03	C Mount PL259
MZL-03	M Mount PL259
MBZL-03	MB Mount PL259
CZL-04	C Mount Crimp Mini UHF
MZL-04	M Mount Crimp Mini UHF
MBZL-04	MB Mount Crimp Mini UHF
CZL-05	C Mount Solder N
MZL-05	M Mount Solder N
MBZL-05	MB Mount Solder N
CZL-06	C Mount Crimp PL259
MZL-06	M Mount Crimp PL259
MBZL-06	MB Mount Crimp PL259
CZL-07	C Mount Crimp N
MZL-07	M Mount Crimp N
MBZL-07	MB Mount Crimp N

CABLE TYPE	LENGTH	CONNECTOR TYPE
A RG58A/U	S 12ft.	-01 TNC
X RG8X	L 17ft.	-03 PL259
Z Z LL-195		-04 Mini UHF
T Teflon®		-05 Type N
		-06 PL259 Crimp
		-07 Type N Crimp

Mounts with 14' of Teflon® Plenum Rated Cable

CTM	C Mount No Connector
MTM	M Mount No Connector
MBTM	MB Mount No Connector
CTM-01	C Mount Crimp TNC
MTM-01	M Mount Crimp TNC
MBTM-01	MB Mount Crimp TNC
CTM-02	C Mount Crimp BNC
MTM-02	M Mount Crimp BNC
MBTM-02	MB Mount Crimp BNC
CTM-03	C Mount PL259
MTM-03	M Mount PL259
MBTM-03	MB Mount PL259
CTM-04	C Mount Crimp Mini UHF
MTM-04	M Mount Crimp Mini UHF
MBTM-04	MB Mount Crimp Mini UHF
CTM-05	C Mount Solder N
MTM-05	M Mount Solder N
MBTM-05	MB Mount Solder N

Shielded CEZM Mount with 14' of LL-195 Cable

CEZM-01	CE Mount TNC
CEZM-02	CE Mount BNC
CEZM-05	CE Mount N
CEZM-10	CE Mount SMA
CEZL	Mount with 17" of LL-195

Gold contacts available on standard mount for no additional charge.

Add G prefix to part number.

Example: G CAL L-Stud Mount cable assemblies are available at same price as other mounts.

Knowledge Experts



MAGNET AND TRUNK MOUNTS

Magnet mounts use heavy-duty magnets bases. Magnet mounts and trunk mounts feature UV inhibited ABS plastic covers and a protective mylar pad.

NMO Magnet Mounts with 12ft of LL-195 Cable

MGZS	Magnet Mount No Connector
MGZS-01	Magnet Mount with TNC
MGZS-02	Magnet Mount with BNC
MGZS-03	Magnet Mount with PL259
MGZS-04	Magnet Mount with Mini-UHF
MGZS-06	Magnet Mount with Crimp UHF
MGZS-05	Magnet Mount with Type N
MGZS-07	Magnet Mount with Crimp N
MGZS-10	Magnet Mount with Crimp SMA

Magnet Stud Mounts with 12ft of LL-195 Cable

MGLAS	L Magnet Mount with No Connector
-------	----------------------------------

NMO Mini-Magnet Mounts with 12ft of LL-195 Cable

MMGAS	Mini-Magnet Mount No Connector
-------	--------------------------------

Mini-Magnet Adapter Mounts with 12ft of LL-95 Cable

MMGSMA-01	Mini Mag SMA with Coax & TNC
MMGTNC-07	Mini-Mag TNC with Coax & "N"
MMGSMA-07	Mini-Mag SMA with Coax & "N"

Trunk Mounts with 17ft of LL-195 Cable

TKAL	Trunk Mount No Connector
------	--------------------------

Trunk Mounts with 17ft of LL-195 Cable

TKZL	Trunk Mount No Connector
TKZL-01	Trunk Mount with TNC
TKZL-02	Trunk Mount with BNC
TKZL-03	Trunk Mount with PL259
TKZL-04	Trunk Mount with Mini-UHF
TKZL-06	Trunk Mount with Crimp UHF
TKZL-05	Trunk Mount with Type N
TKZL-07	Trunk Mount with Crimp N

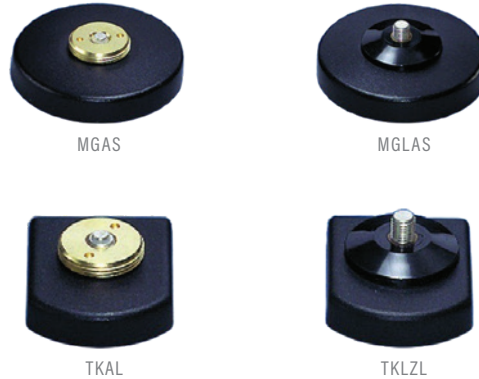

- Very low loss version of MMGN for use at frequencies above 900MHz.
- These are custom built to specification. Call for info and pricing.
- Ask about MMGLL.

To Order Magnet or Trunk Mounts

MG	M Type Mount	TK	M Type Mount
MGL	L Type Mag Mount	TKL	L Type Mount
MMG	Mini Mag Mount		
MMGTNC	Mini Mag TNC Type Mount		

Add: Cable Type, Length and Connector

EXAMPLES:

MGAS-01 = M Type Magnet Mount with 12 ft. RG58A/U and TNC
TKLZL-02 = L Type Trunk Mount with 17 ft. Micro Loss 900 and BNC

Custom cable assemblies are available upon request.

Ordering Guide for Custom Cable Assemblies

We stock many standard coaxial connectors and various types of cable. We can build to order custom assemblies at very competitive prices using our automated cable assembly equipment.

When ordering cable assemblies please follow the simple table below to create a part number for your selection.

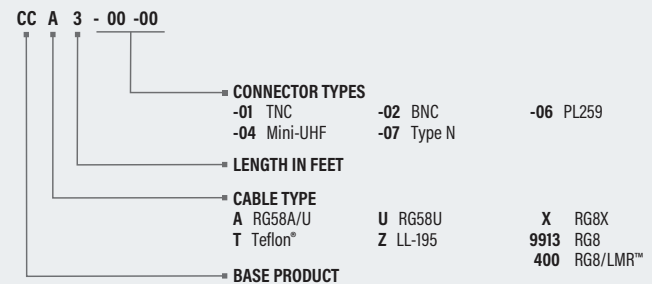

SPECIALTY MOUNTS & BRACKETS

Mobile to Base Adapters

BSMOLC-VHF	VHF Adapter N Type
BSMOLC-UHF	UHF Adapter N Type
BSMOLC-800	800/900 Adapter N Type
BSMO	Heavy Duty Adapter

Note: Specify VHF/UHF and Connector Type N or S0239

Adapter Brackets

UNIBKT	Universal Bracket .625 Hole
BKT1	Mast Mount for CC Series Power Divider
BKT2	Mast Mount for 66 Series Yagi and EDX
2Y66HDBKT	Mast Mount for 2Y66HD Yagi & CC Series Power Divider
TMBM	Stainless Trunk 3/4" Hole, Brite
TMBMB	Stainless Trunk 3/4" Hole, Black
TMBC	Stainless Trunk 3/8" Hole, Brite
TMBCB	Stainless Trunk 3/8" Hole, Black
MMM	Mirror Mount Bracket 3/8 Hole, Black
MMNMO	Mirror Mount with NMO 17' LL-195 Coax
MMCM	Commercial Mirror Mount 12' LL-195 Coax Must specify Connector Type
BSMN	Mirror Mount, NMO "N" Connector
BSMONN	BSMO with "N" to "N" Female, Zinc U Bolts
SSU	Stainless Steel U Bolts #7 ea.

Thick Body Mounts

TBML	Thick Body Mount 17ft LL-195 N.C. Up to 1/4" Thick Plate, 3/8 or 3/4 Hole
VTBML	Very Thick Body Mount 17ft LL-195 N.C. Up to 1/2" Thick Plate, 3/8 or 3/4 Hole
UTBN	Universal Thick Body Mount "N" Termination
UTBM	Mount terminates as MINI-UHF
TAUHF	Thick Adapter UHF
TAN	Thick Adapter N

UTCM Mount Only

UTCM-GP	Ceiling Mount Mini UHF with GP
---------	--------------------------------

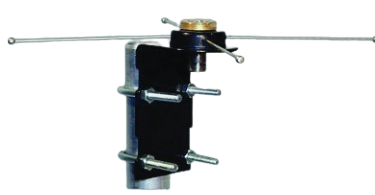

BSMO450

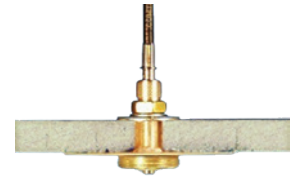

UTCM



UNIBKT



BKT1



BKT2



2Y66HDBKT



MMM



TMBM



UTBM



MMCM



MMNMO



BSMN



TAUHF, TAN

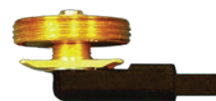

TBML



VTBML



ACCESSORIES

Accessories for Mobile Antennas

11B	Classic Base Only
11BSC	Classic Base, Contact & Adapter
11BBSC	Black Classic Base, Contact & Adapter
15BSC	Shock Spring Base, Contact & Adapter
15BBSC	Black Shock Spring, Contact & Adapter
11SS	Classic Shock Spring
11SSB	Black Shock Spring
BLCSS	Shock Spring
BBLCSS	Black Shock Spring
15B 15	Series Base Only
BLC-XX	Loading Coil
BBLC-XX	Black Loading Coil
BLCA-XX	Loading Coil & Adapter
BBLCA-XX	Black Loading Coil & Adapter



Add Frequency Suffix for Above Coils

-27: 27-31MHz	-45: 45-54MHz	-4306: 406-512MHz 3dB	-4570: 470-490MHz 5dB
-30: 30-35MHz	-144: 144-174MHz	-4506: 406-430MHz 5dB	-4590: 490-512MHz 5dB
-34: 34-40MHz	-200: 200-250MHz	-4530: 430-450MHz 5dB	
-39: 39-45MHz	-250: 250-280MHz	-4550: 450-470MHz 5dB	



11CAB Classic Adapter Bushing
11BAB Black Classic Adapter Bushing
18CAB Chrome Base Load Adapter
18BAB Black Base Load Adapter
11SC Spring Loaded Contact
11WSC Wide Spring Loaded Contact
MBMR M Style Mounting Ring
CBMR C Style Mounting Ring
CSSS C Style Stainless Steel Saddle
14BLN Black Locking Nut
14CLN Chrome Locking Nut
14CRC Chrome Rain Cap
14BPRC Black Plastic Rain Cap
14MGS 14 Series Internal Gasket Seal (6)
11MEGS 11 Series External Gasket Seal (6)
18MOR 18 Series O Ring Seal (6)
MOR Mount Kit O Ring (6)
13" GP58 Ground Plane 5/8" hole
13" GP38 Ground Plane 3/8" hole
4" GP58 Ground Plane 5/8" hole
4" GP38 Ground Plane 3/8" hole
8" GP58 Ground Plane 5/8" hole
8" GP38 Ground Plane 3/8" hole

Battery Tap

A1001A Battery Tap (5 individually Packed)
A1001B Battery Tap (25 bulk packed)

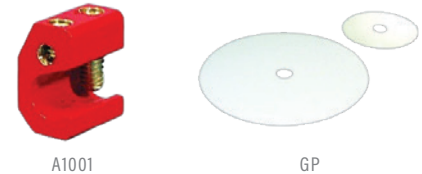

Replacement Whip Assemblies

WPDB Dual Band Whip .100
WPDBB Dual Band Whip .100, Black
WPDB33 Dual Band Whip Assembly, 4dBd
WPDB33B Dual Band Whip Assembly, 4dBd, Black
WPQ 20" Stainless Whip .100
WPQB 20" Stainless Whip .100, Black
WPBL125 52" Stainless Taper Whip .125
WPBL100 52" Stainless Taper Whip .100
WPBL100B 52" Stainless Taper Whip .100, Black
WPEF Elevated Feed Whip Assembly
WP85A-X 3.5dBd Whip Assembly 800MHz
WP85B-X 3.5dBd Whip Assembly 800MHz, Black
WP855A-X 5dBd Whip Assembly 800MHz
WP855B-X 5dBd Whip Assembly 800MHz, Black
WP45A-X 3.5dBd Whip Assembly 450MHz
WP45B-X 3.5dBd Whip Assembly 450MHz, Black
WPBL45AX 5dBd Base Load Whip 450MHz
WPBL45BX 5dBd Base Load Whip 450MHz, Black

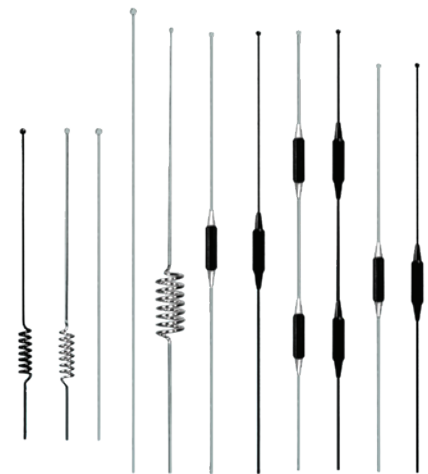

REPLACEMENT WHIPS

ORDERING INFORMATION FOR MOBILE MARK, INC AND COMTELCO BRANDED PRODUCTS (USA)



ORDERING PROCEDURES

Mobile Mark Inc., Comtelco branded products can be ordered by phone, or e-mail. Orders can be submitted directly to Mobile Mark Inc., a Representative, or through a distributor. Mobile Mark sells products to VAR/resellers, distributors, OEM Manufacturers, certain government entities, and research organizations. If you are interested in a product for your own private use, please contact us for the nearest reseller in your area.

TERMS OF PAYMENT

Open account terms of Net 30 are offered, after appropriate credit approval. Minimum Information required is one signed bank reference form and three (3) trade references.

For convenient ordering, Mobile Mark Inc. also accepts VISA, Mastercard, Discover card and American Express. other forms of payment include wire transfer (EFT).

SHIPPING TERMS

Mobile Mark Inc. products are shipped Ex-Works (EXW), Itasca, IL. This means that prices quoted or shown in our literature do NOT include shipping. Our standard shipper is UPS. Some products must ship ground freight, due to size limitations. Shipping charges are added to your invoice. UPS shipments are available in Red (Overnight), Blue (2 day), Orange (3 day) and ground. Shipping charges are assessed once an order is completed and can be weighed.

Although we do not guarantee shipping charges in advance, we can usually provide you an estimate beforehand for planning purposes.

If you wish to use Fedex or DHL, you may provide us your account number for shipping. For shipments outside of USA required shipping carrier and method.

RETURNING PRODUCT

Returns are accepted for defects or mistakes on our part in processing your order. Our products are generally warranted for 3 years (see warranty on website). If you need to return Mobile Mark product under warranty, you must first contact us to receive a return authorization number and approval. For warranty items, product will be repaired or replaced. When you return damaged product, the RMA number must be clearly visible on the shipping label.

CHANGES IN PRODUCT/PRICING/SHIPMENT

Mobile Mark, Inc. reserves the right to make product specification changes or pricing changes at any time, without notice. When you order an item, Mobile Mark will give you an approximate shipment date. If an item needs to be back ordered, we will notify you, and ask for permission to ship any partial/available products.

Distributor name and contact info: _____

Notes: _____



ORDERING INFORMATION FOR MOBILE MARK, LTD. AND COMTELCO BRANDED PRODUCTS (EUROPE)



ORDERING PROCEDURES

Mobile Mark Inc., Comtelco branded products can be ordered by phone, e-mail. Orders can also be submitted to any Mobile Mark (Europe) Authorized Distributor.

Mobile Mark, LTD. (Europe) sells to Resellers, VARs, Distributors, OEM Manufacturers, certain government entities, and research organizations. If you are interested in a product for your own private use, please contact us for the nearest reseller in your area.

Many Mobile Mark products can be purchased through Distributors. Some Distributors stock certain models for immediate shipment. Mobile Mark builds products to order. The majority of our products have a 2 week or more lead time, and a few items are 1 week. These lead times do not include shipping.

TERMS OF PAYMENT

Open account terms of Net 30 are offered, after appropriate credit approval.

For purchases by credit card, Mobile Mark Inc., LTD. (Europe) accepts VISA and MasterCard. Other forms of credit include BACS, Cash in Advance and wire transfer.

SHIPPING TERMS

Mobile Mark products are shipped Ex-Works (EXW) UK, Incoterms 2010. This means that prices quoted or shown in our literature do not include shipping. Shipping charges are prepaid and are added to the invoice or COD charge.

We use a variety of shipping companies including FedEx, UPS, DHL and local freight forwarding companies.

If you have a specific shipper you wish to use, please let us know. Many of our customers specify their own courier and consolidate shipments. If you need further assistance finding a freight forwarder, we can put you in touch with one.

RETURNING PRODUCT

Returns are accepted for defects or mistakes on our part in processing your order. Our products are generally warranted for 2 years (see warranty on website). If you need to return Mobile

Mark product under warranty, you must receive a return authorization number and approval from Mobile Mark. To do so, simply call us or email us. For warranty items, product will be repaired or replaced. When you return damaged product, the RMA number must be clearly visible on the shipping label.

CHANGES IN PRODUCT/PRICING/SHIPMENT

Mobile Mark, LTD. (Europe) reserves the right to make product specification changes or pricing changes at any time, without notice. When you order an item, Mobile Mark will normally give you an approximate shipment date. If an item needs to be back ordered, we will typically notify you and ask for permission to ship the available products as a partial order.

Distributor name and contact info: _____

Notes: _____



All Mobile Mark products
are ROHS & WEEE
Compliant



Thank you!

To our existing customers, I thank you for your loyalty, trust, and patronage in our Comtelco products. I welcome new customers to explore our line of quality products and learn why this brand has successfully grown for over 40 years.

The Comtelco brand embodies the reliability and high performance our customers expect.

In addition, Mobile Mark is committed to providing strong Business Partnership, Wireless Expertise, and Engineering Excellence with products locally made in the USA & UK.

Michael Berry, President & CEO

COMTELCO ANTENNAS

A Family Brand of Mobile Mark



COMTELCO ANTENNAS

A Family Brand of **MobileMark**



US location:

Mobile Mark, Inc.
1140 W. Thorndale Ave.
Itasca, IL 60143, USA

- Global Headquarters
- Engineering Design Center
- Environmental Testing Facilities
- Expanded Manufacturing Space

Toll free: 1-800-648-2800 (US & Canada)

Phone: 1-847-671-6690

Fax: 1-847-250-5120

Email: info@mobilemark.com



UK location:

Mobile Mark Europe, Ltd.
8 Miras Business Park
Hednesford, Staffordshire, WS12 2FS, UK

- European Production Facility
- Expanded Manufacturing Space
- ISO-9001 Certified

Phone: +44 1543 459555

Fax: +44 1543 459545

Email: inquiries@mobilemarkeurope.co.uk

